

**B**

VS 10-75 CG uPC (AHU VS 21-75)  
VS 40-150 CG uPC SUP-EXH  
VS 180-300 CG uPC  
VS 400-650 CG uPC

APPLICATION: AR4104 / AR4232

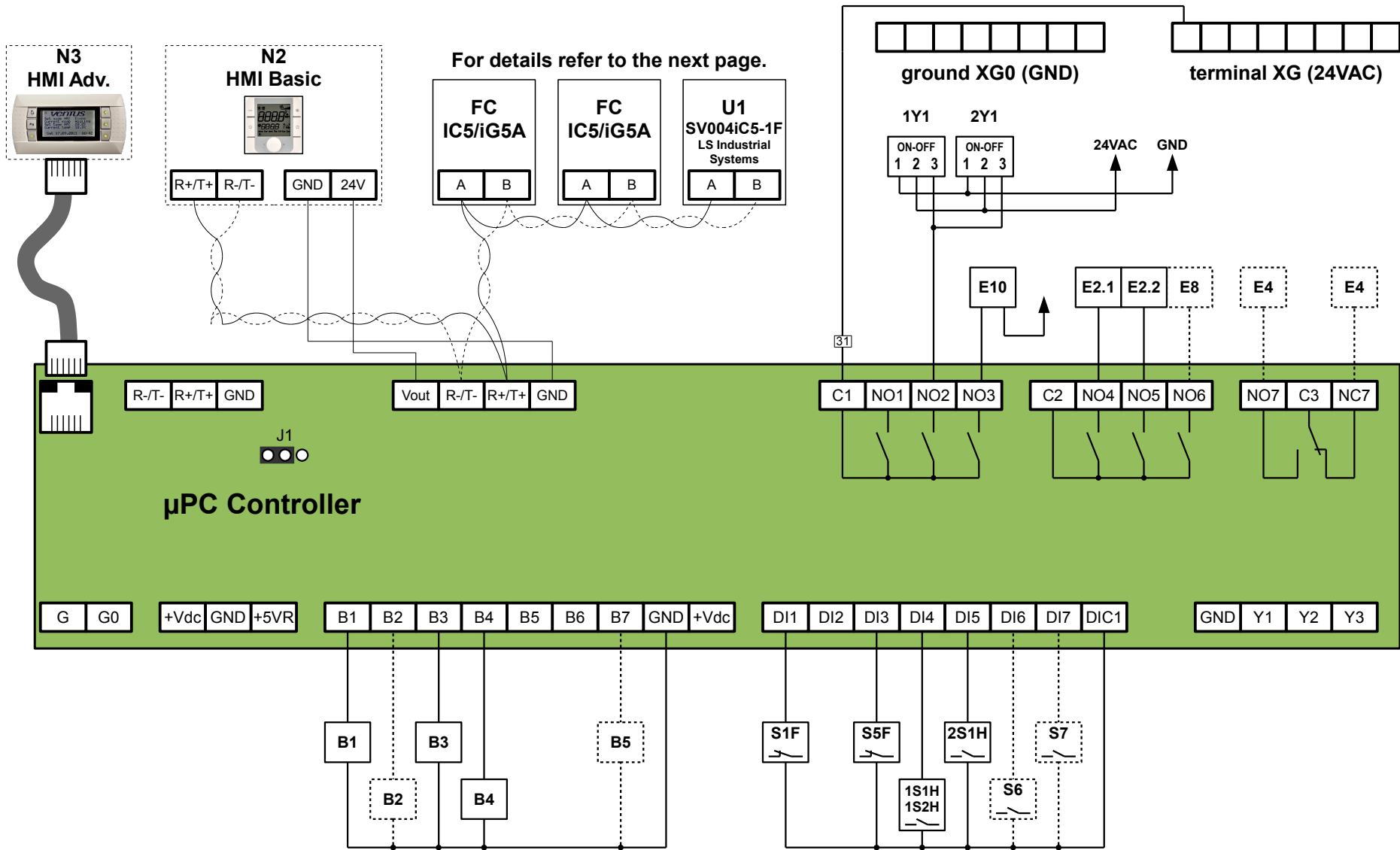

**B**

**MODBUS CONNECTION**



**SENSOR B2**

	HMI Basic uPC = YES	HMI Basic uPC = NO
App.Code A...-S	✗	✗
App.Code A...-R	✗	B2 ✓
App.Code A...-E	B2 ✓	B2 ✓